

American Standard



Last As Long As The Building



ELKAY



KOHLER
FAUCETS®



POWERS



SLOAN®

Symmons
INDUSTRIES INC.



ZURN

Section 0 FAUCETS

Table of Contents

UNIVERSAL BRASS 0-2

American Standard.....0-2 - 0-5

Chicago.....0-6 - 0-10

Delta0-11

Elkay..... 0-12

Fisher..... 0-13

Kohler..... 0-14

Moen.....0-14 - 0-15

Powers 0-15

Sloan 0-16

Symmons..... 0-17

T&S0-18 - 0-21

Zurn.....0-22 - 0-24

Phone (650) 368-8517



Fax (650) 367-0732

Faucets

Institutional Faucets



75729

Polished chrome plated widespread faucet with adjustable centers from 6" to 20", a low profile spout, quarter turn ceramic disc cartridges, and color coded vandal resistant handicap wrist blade handles.

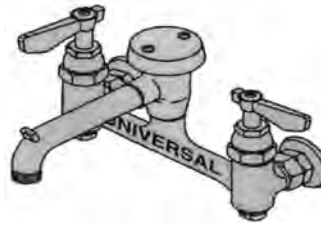

75230

Built in screwdriver stops. Integral check stems. 1/2" FPT inlets. - 2-1/2" spout Chrome plated brass. 3/4" male hose thread on spout. 7-1/2" to 8-1/2" wall centers.



75728

Polished chrome plated widespread faucet with adjustable centers from 6" to 20", a gooseneck spout, quarter turn ceramic disc cartridges, and color coded vandal resistant lever handles.



75727

Polished chrome plated wide-spread faucet with adjustable centers from 6" to 20", a goose-neck spout, quarter turn ceramic disc cartridges, and color coded vandal resistant handicap wrist blade handles.

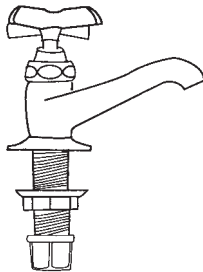

SINGLE BASIN FAUCET

Solid brass body with metal handles and deluxe aerator. Chrome plated.

75130 - Cold

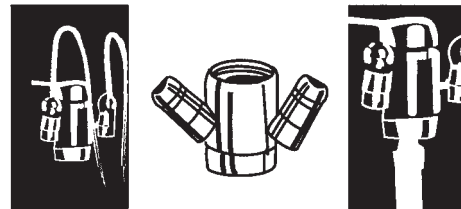

75140

FAUCET MOUNTED EYEWASH

Attaches to any faucet. Includes adaptors. Diverter button operates eye wash to aerator flow.

American Standard

BEDPAN CLEANERS

Heritage



Bedpan cleaner, self-closing valve with spray, 4' rubber hose, wall nozzle with hook, for use with valve stop (NOT INCLUDED).

Number **OEM No.**
***** 7866.115

***** *Special ordered item*

Heritage

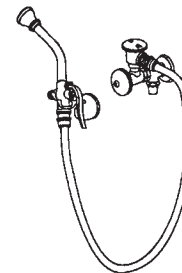

Bedpan cleaner, wheel handle, self-closing spray, vacuum breaker, 45-5/8" rubber hose, wall hook.

Number **OEM No.**
***** 7582.167

***** *Special ordered item*

American Standard

Lavatory Faucets for Commercial Use

Heritage

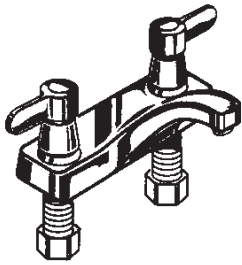

3-9/16" reach, 3" height, 2-3/16" clearance, 1/2" IPS male inlets.

Number	OEM Number	Drain
--------	------------	-------

Vandal resistant aerators, drains, and connections on factory installed handles:

*****	5400.142H	Less Drain
With factory installed handles:		
*****	5401.142H	Pop-up
*****	5402.142H	Grid
*****	5400.142H	Less Drain

***** *Special ordered item*

Heritage

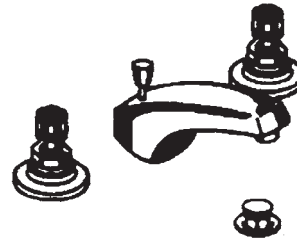

Rigid gooseneck spout, 5" spout reach, 9-1/4" height, 5-5/16" clearance, **less handles.**

Number	OEM No.	Drain
--------	---------	-------

*****	4801.000	Pop-up
*****	4802.000	Grid
*****	4800.000	Less Drain

***** *Special ordered item*

Heritage

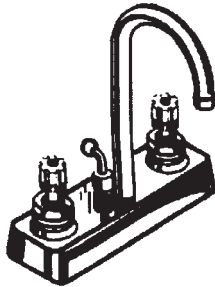

Rigid gooseneck spout, 5" spout reach, 9-1/4" height, 5-5/16" clearance, **less handles.**

Number	OEM No.	Drain
--------	---------	-------

*****	7401.000	Pop-up
*****	7402.000	Grid
*****	7400.000	Less Drain

***** *Special ordered item*

Heritage

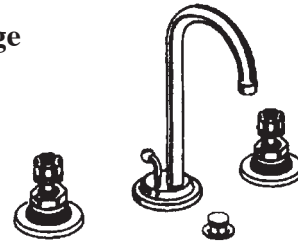

Flexible 6" - 12" centers, 1/2" IPS male inlets, gooseneck spout, 5" reach, 10-5/8" height, 6-1/2" clearance, **less handles.**

Number	OEM No.	Drain
--------	---------	-------

*****	7831.000	Pop-up
*****	7830.000	Less Drain

***** *Special ordered item*

Handle Options



Crown



Acrylic



Wrist Blade



Four Arm Lever



Lever

Single Control Lavatory Faucets

For Commercial and Hospital Use

Ceramix

ADA



Escutcheon plate, 3/8" OD copper inlets, 4-5/8" reach, 2-7/16" clearance.

Number	OEM No.	Drain
--------	---------	-------

*****	2000.100	Less
-------	----------	------

***** *Special ordered item*

Faucets

American Standard

BACKMOUNT COMMERCIAL UTILITY SINK FAUCETS

Heritage

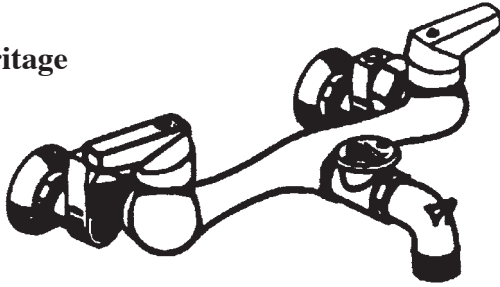

8" centers, 1/2" IPS female inlets, hose thread outlet, bucket hooks, vacuum breaker lever handles. Rough chrome finish.

Number	OEM No.	Description
****	8350.235	Less vacuum breaker (shown)
****	8350.243	With vacuum breaker
****	8351.076	With stops in shanks

**** Special ordered item

Heritage Amarilis

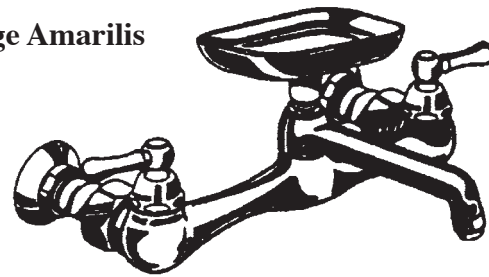

Wall mount, 8" centers, 1/2" IPS female inlets, 5-5/8" swivel spout, metal lever handle, with soap dish.

Number	OEM No.
****	7295.152

**** Special ordered item

Heritage

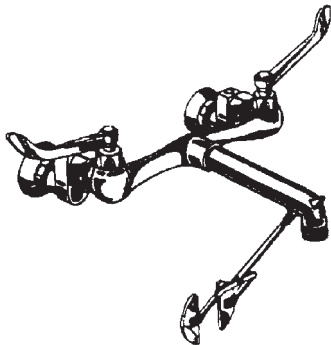

Adjustable centers, 1/2" IPS female inlet shanks with integral stops, bucket hook, bottom brace, wrist blade lever handles.

Number	OEM No.	Reach
****	8355.101	10-1/4"
****	8345.115	14-3/4"

**** Special ordered item

Heritage

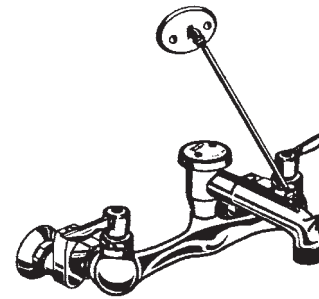

Adjustable centers, 1/2" IPS female inlet shanks with integral stops, hose thread outlet, vacuum breaker spout, bucket hook, wall brace, 4-arm lever handles.

Number	OEM No.	Description
****	8354.112.002	Polished chrome
****	8354.112.004	Rough chrome

**** Special ordered item

Deckmount Faucets for Commercial Use

Heritage



Single hole, swivel gooseneck spout, 5" reach, 13-1/4" height, 9-3/8" clearance, 1/2" IPS male inlet, Heritage lever handle.

Number	OEM No.
****	7100.241H

**** Special ordered item

Amarilis

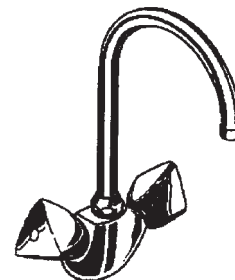

Single hole, brass swivel spout, 5" reach, 11-1/2" clearance, 3/8" OD supplies.

Number	OEM No.
****	7190.132

**** Special ordered item

Deckmount Faucets for Commercial Use

Heritage

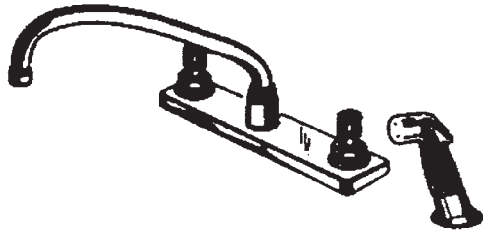

Deck mount with swing spout. Solid brass, washerless cartridges. 1/2" male threaded inlet shanks w/ brass coupling nuts.

Number	Oem No.	Spray
*****	6279.000	Less
*****	6270.000	With

***** *Special ordered item*

Knee and Pedal Valves

Heritage

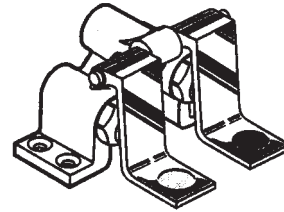

Floor mount pedal valve, screwdriver stops, 3/8" floor inlets on 2" centers, 3/8" back outlet.

Number	OEM No.
*****	7680.210

***** *Special ordered item*

Heritage

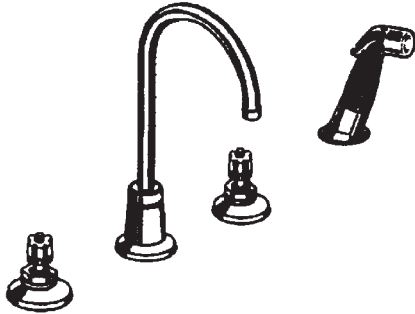

Concealed mount, 1/2" IPS male inlets, gooseneck swing spout, 9" reach, 12-1/8" height, 6-1/4" clearance. **Less handles.**

Number	OEM No.	Spray
*****	7230.000	Less
*****	7231.000	With

***** *Special ordered item*

Heritage

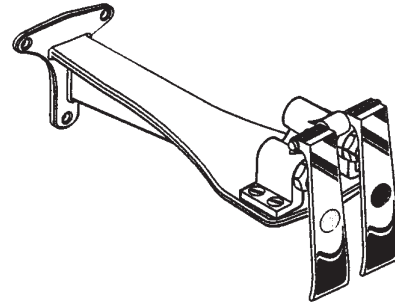

Knee valve, 6" centers, 3/8" FIP inlets, screwdriver stops, wall support bracket.

Number	OEM No.
*****	7676.129

***** *Special ordered item*

Handle Options



Crown



Acrylic



Wrist Blade



Four Arm Lever



Lever

Heritage

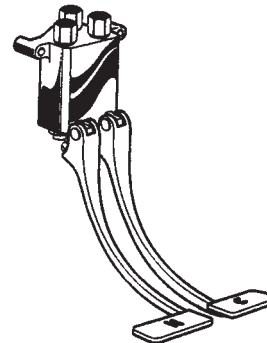

Wall mount pedal valve, 3/8" back inlets on 2" centers, 3/8" top outlet, 14-5/8" total pedal reach, screwdriver stops.

Number	OEM No.
75302	7679.112

***** *Special ordered item*

MVP Metering Fittings

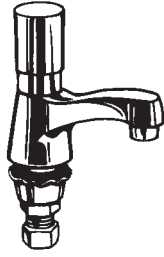

Single metering "push" fitting.

Number	OEM No.
75608	333-665PSHAB

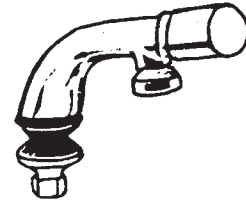

Self-closing metering cartridge closes automatically. Timing from 1 to 20 seconds. Push handles.

Number	OEM No.
75611	807E12665PSHAB

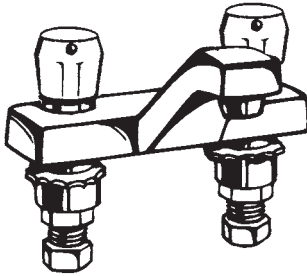

4" centerset metering fitting.

Number	OEM No.
75610	802-665ABCP

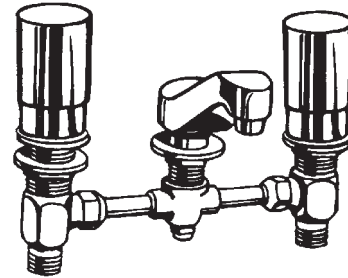

8" widespread metering fitting.

Number	OEM No.
75613	404-665ABCP

FAX LINE

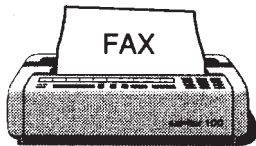

(650) 367-0732

ORDER DESK



(650) 368-8517

Lavatory Fittings

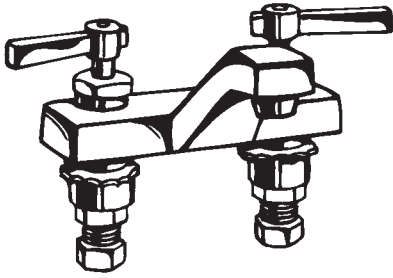

Quaturn lavatory centerset with brass stems.

Number	OEM No.	Handles
75630	802-VAB	Lever
75632	802V-1000AB	Lever canopy
75640	802V-317AB	Wrist blade

Hi-Lite

Quaturn lavatory fitting with GN-1A-E3 rigid/swing convertible gooseneck spout. No. 3 3-GPM softflo aerator. No. 369 handles - color coded. Brass stems.

Number	OEM No.	Description
75636	895-AB	With gooseneck spout

No. 317-4" wrist blade handles. No E3 softflo aerator.

Number	OEM No.	Description
75639	895-317AB	Without pop-up

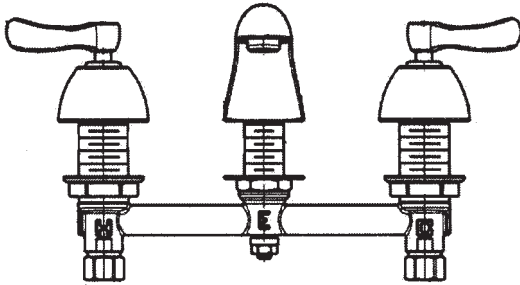
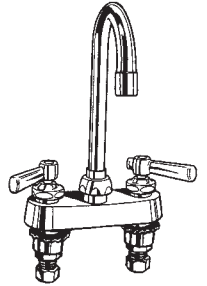

Hi-Lite quaturn widespread fitting.

Number	OEM No.	Description
75602	404-ABCP	Less pop-up

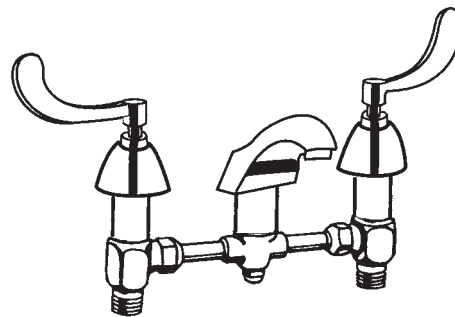

Deck mounted fitting. 5" spout. E12 Softflo aerator. Wrist blade handles and Quaturn operating cartridge.

Number	OEM No.	Description
75643	404V-317ABCP	Handicap faucet



Single sink fitting with 633 handle and aerator.

Number	OEM No.
75627	701-COLDAB

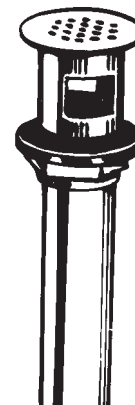

P.O. plug has 1-1/4" tailpiece and heavy cast brass stopper.

Number	OEM No.	Description
45522	327	P.O. plug (shown above)

Faucets



Self-Closing Fittings

Naiad

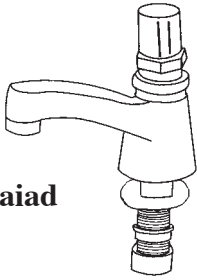

Push button self-closing single basin fitting. No. 333-27K slow closing dashpot. E12 3-GPM softflo aerator. Closing time adjustable. 3-3/8" cc, basin cock spout.

Number	OEM No.
75638	333-SLOE12COLDABCP

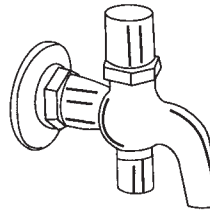

Self-closing push button sink faucet. 1.6 GPM softflo in lieu of volume regulator in shank. Flanged female 1/2" IPS. Back of flange to center of outlet 4". Vandal-proof free turning insulated push button.

Number	OEM No.
75497	324-665PSHCP

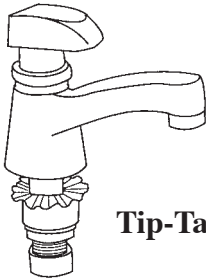

Tip-Tap

Slow closing single basin fitting with no. 333-27K slow closing dashpot, no. E12 3-GPM softflo aerator. Adjustable closing time. 3-3/8" cc, basin spout.

Number	OEM No.
75136	335-E12-COLDABCP



Slow closing centerset lavatory fitting. Renewable operating units. Adjustable closing time. Hinged handles. 4" spout. No. E12 3-GPM softflo aerator.

Number	OEM No.
75637	802A-V335ABCP

Tip-Tap

Backmount Sink Fittings

Hi-Lite

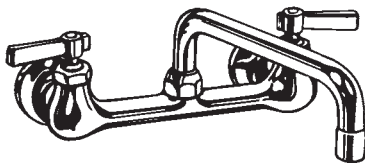

Quatern straight 8" sink fitting. With #369 color coded handles, #S6 6" swing spout, #E3 softflo aerator, #G-1/2" flanged female supply arms adjustable from 7-1/4" to 8-3/4" centers. Body inlets - 8" centers.

Number	OEM No.
75473	540-LDABCP

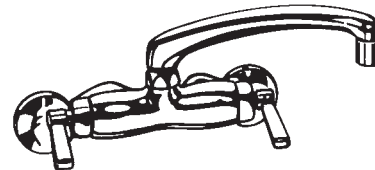

Quatern sink fitting with #369 color coded handle, #L8 8" swing spout, #E3 softflo aerator & #H-1/2" flanged female supply arm. Supply arms adjustable from 4" to 8-3/8" centers. Body inlets 3-3/8" centers.

Number	OEM No.
75474	445-L8ABCP



Wall mounted fitting. Vacuum breaker spout with pail hook and wall brace. 3/4" male hose thread outlet. Quatern operating cartridge. Adjustable supply arms - from 7-5/8" to 8-3/8" centers. Rough chrome finish.

Number	OEM No.
75477	897-RCF

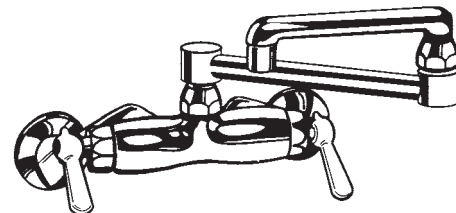

Quatern sink fitting with #369 color coded handles, 13" double jointed swing spout, E3 aerator and adjustable supply arms from 4" to 8-3/8".

Number	OEM No.
75616	445DJ13CP

Backmount Sink Fittings

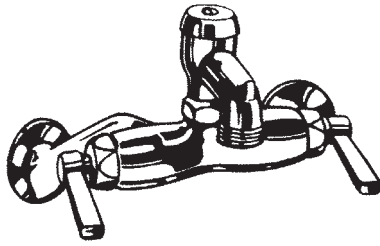

Quaturn short spout service sink fitting. Vacuum breaker, 3/4" hose thread, pail hook on spout. With #369 color coded handles and #R integral stop arms. Supply arms adjustable from 4" to 8-3/8" centers. Rough chrome finish.

Number	OEM No.
75478	305-VBRRCF

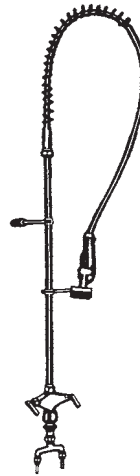

Pre-rinse unit with deck type mixing faucet. 1/4" IPS check tailpieces on 3-1/2" centers. Integral checks to prevent cross flow of water. 3/8" IPS x 23" riser and riser support wall bracket. 36" flexible stainless steel hose. Self closing valve has insulated handle, hold down ring, rubber bound spray, adjustable hose valve hook. Unit is approximately 44" high.

Number	OEM No.	Description
75499	919-LCP	Pre rinse unit
81060	80-HCP	Spray head, only

Quaturn Top Mount Sink Fittings

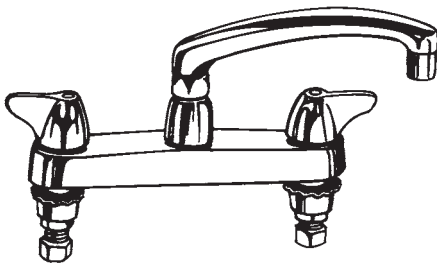

Quaturn top mount sink fitting. 8" centers with #L8 8" swing spout, #E3 soffflo aerator & #1000 color coded handles.

Number	OEM No.
75471	1100ABCP

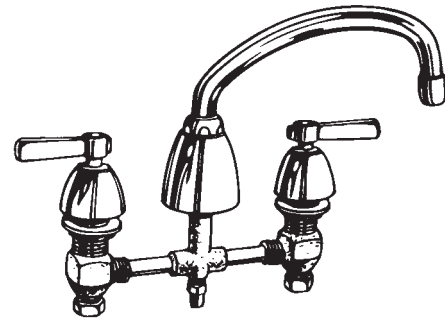

Quaturn top mount sink fitting, 8" centers with #L9 9" swing spout and #E3 soffflo aerator.

Number	OEM No.
*****	201-AABCP

***** *Special ordered item*

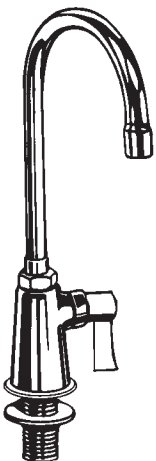

Quaturn single deck fitting with #GN-2A rigid/swing convertible gooseneck spout, #E3 soffflo aerator & #396 handle.

Number	OEM No.
75498	350ABCP

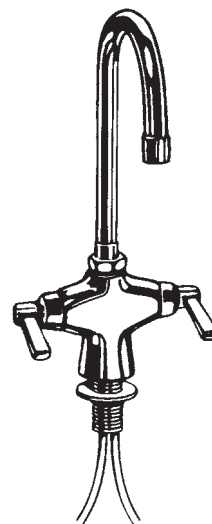

Quaturn double pantry sink fitting with #GN-2A rigid/swing convertible gooseneck spout, #E3 soffflo aerator & #369 handles. 3-1/2" centers.

Number	OEM No.
75475	50-ABCP

Faucets



Last As Long As The Building

Hospital Fittings

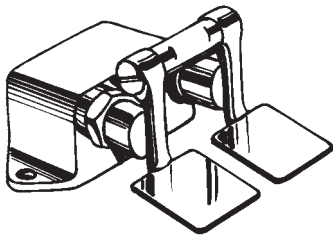

Double pedal valve. Two back inlets. One back outlet. Mixing type inlets are 1/2" IPS and outlet is 3/8" IPS. Floor mount. Polished chrome finish.

Number	OEM No.	Pedals
75492	625ABCP	Regular
75494	625-LPABCP	Extended

***** Special ordered item

Hi-Lite

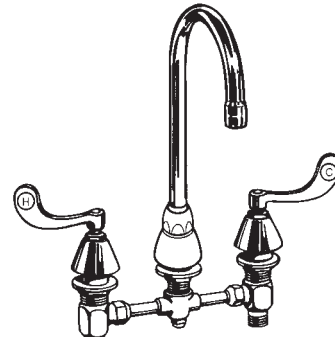

Quatern widespread hospital fittings. No. 317 4" color coded blade handles with GN-1A-E3 rigid/swing convertible gooseneck 8-1/4" spout with 3-1/2" reach, & #E3 3 GPM soffflo aerator.

Number	OEM No.
75481	786-GN1AE3ABCP

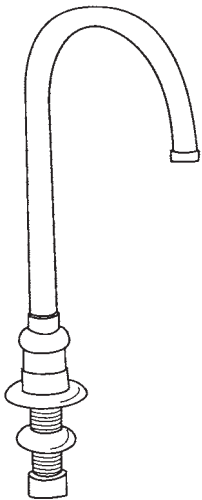

Pedal & knee action valve spout. No. GN 2A-E3 rigid/swing convertible spout & #E3 soffflo aerator.

Number	OEM No.
75496	626-E3ABCP

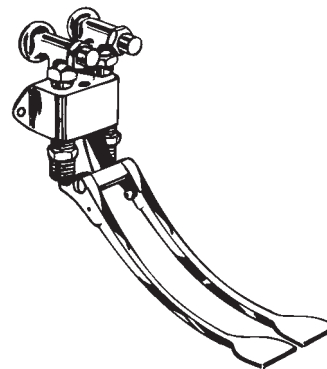

Double 14" pedal valve. Wall mount. 1/2" inlets, 3/8" outlets. Polished chrome finish.

Number	OEM No.
75493	834-EPCP

Laboratory Fittings

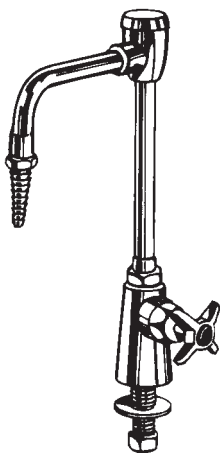

Single sink fitting with rigid/swing convertible gooseneck spout, vacuum breaker and serrated nozzle.

Number	OEM No.
75485	928CP

***** Special ordered item

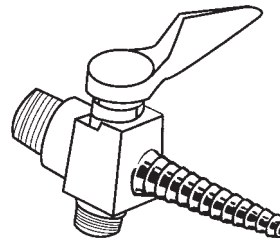

Laboratory gas / hose cock. For low pressure gas application only. Ground key cock. 3/8" IPS male inlet.

Number	OEM No.
75482	909-AGVCP

Heavy Duty Commercial Faucets

Residential Faucets

ADA

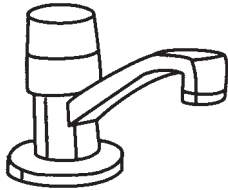

Slow self-closing single basin faucet for hot or cold. Vandal resistant handle, and 1/2 GPM vandal resistant aerator.

Number	OEM No.
75532	701HDF

ADA



Latest design with stainless steel control ball and lever handle.

Number	OEM No.	Description
75439	500DST	Without pop-up
75440	520-MPU-DST	With pop-up

ADA

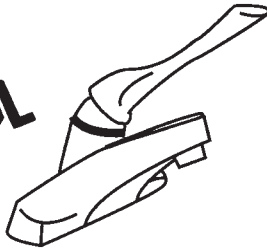

75534

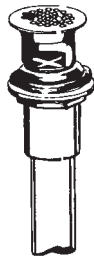

45506

Work Force bathroom faucet on 4" centers. No lift rod hole. Long handicap handle. Includes stainless steel ball. Unit to be used with 45506 grid strainer.

Number	OEM No.	Description
45506		Grid strainer 1-1/4" x 8"
75534	511LFHDF	Work Force bathroom faucet

ADA

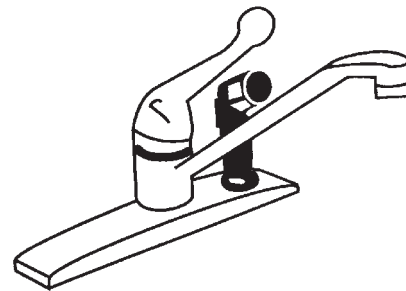

Delta single lever kitchen faucets with or without spray. 3 hole sink installation. 8" centers with 8" swing spout.

Number	OEM No.
75438	100WF - without spray
75452	300WF - with spray

ADA

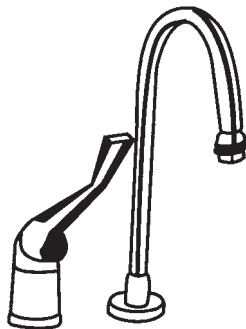

Single handle utility faucet with elbow handle and rigid gooseneck spout.

Number	OEM No.
75526	710LF-HDF

ADA

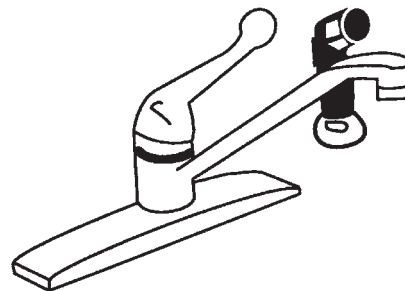

Delta single lever kitchen faucet with spray. 4 hole sink installation. 8" centers with 8" swing spout.

Number	OEM No.
75453	400WF



ADA



Single lever deck mount swing spout. 3/8" OD inlets, 6" height, 5" clearance, 8" reach, H type cartridge.

Number	OEM No.	Spray
*****	LKE4101	With
*****	LKE4100	Less

***** *Special ordered item*

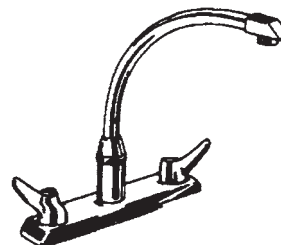

ADA



Deck mount, 8" centers, 1/2" IPS inlets, hi-arc swing-spout, 11-1/4" height, 10" clearance, 8" reach, D type cartridge, wing handles.

Number	OEM No.	Spray
*****	LKD2443	With
*****	LKD2442	Less

***** *Special ordered item*

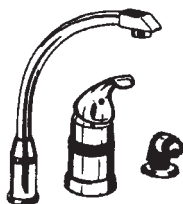

ADA



3-hole installation (with spray) or 2-hole installation (less spray) hi-arc swing spout, 11-1/4" height, 8" reach, 10" clearance, H type cartridge, metal lever handle.

Number	OEM No.	Spray
*****	LKE4123	With
*****	LKE4121	Less

***** *Special ordered item*



ADA



Single post mount, 1/2" IPS inlet, rigid gooseneck spout, 8" spout height, 4-3/8" clearance, 4-3/4" reach, wing handle.

Number	OEM No.	Handle
*****	LKD20858	Right

***** *Special ordered item*

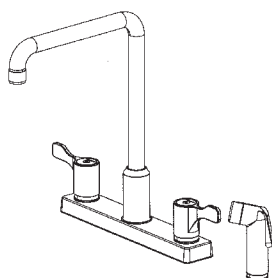

8" centerset exposed deck mount with twin handles. Multi-swing spout with adjustable positions. Removable cartridges. Chromes plated brass body and spout Water-saving flow restrictor. Side spray.

Number	OEM No.
*****	LKD2443

***** *Special ordered item*

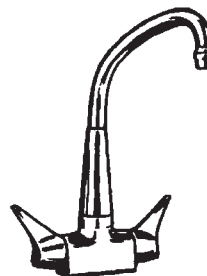

ADA



Single post-mount, 3/8" OD inlets, hi-arc swing spout, 12-3/8" spout height, 9-7/8" clearance, 5-5/8" reach, wing handles.

Number	OEM No.
*****	LKD2223

***** *Special ordered item*

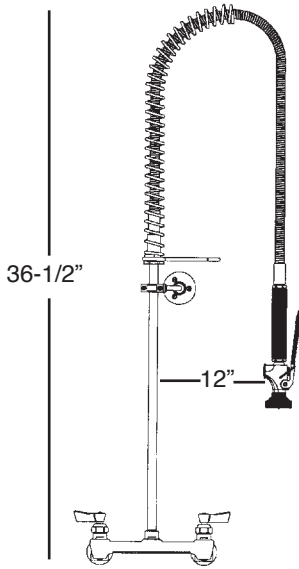

Wall mount pre-rinse unit. Adjustable 7-1/2" to 8-1/2". Eccentric mounting connectors.

Number	OEM No.
75759	2210

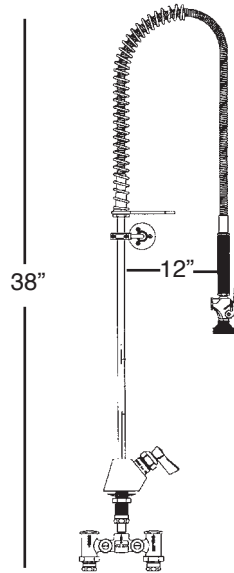

Deck mount hot & cold pre-rinse unit. Hot and cold water comes through single 1-1/16" diameter shank. Comes complete as shown.

Number	OEM No.
75760	2010

Wall Bracket Only
75762 2902-12

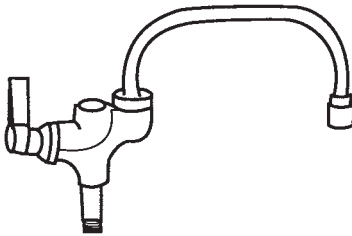

Pre-rinse 3/8" IPS add-on faucet. Fits all Fisher pre-rinse units. 6" spout.

Number	OEM No.
75761	71323

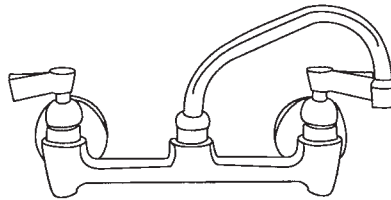

Wall mounted swing spout faucet. Polished chrome. Adjustable 7-1/2" to 8-1/2". Includes 2.75 GPM Flo-Restrictor aerator. Brass lever handles.

Number	OEM No.	Spout Size
75763	53104	6"
75764	53112	8"
75765	53120	10"
75766	53139	12"
75767	53147	14"

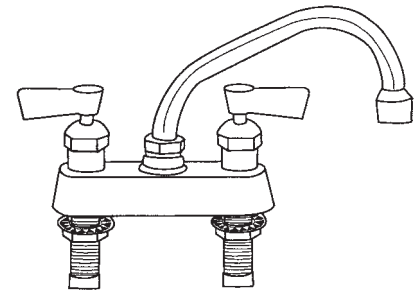

4" center deck mount faucet

Number	OEM No.	Spout Size
75775	53740	6"
75776	53767	10"

KOHLER FAUCETS®

Triton

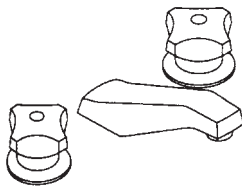

Widespread lavatory faucet. 5" spout, standard handles, flexible connectors, less drain and lift rod. For 8" to 16" centers. Chrome plated.

Number	OEM No.
*****	K-7443-2ACP

***** *Special ordered item*

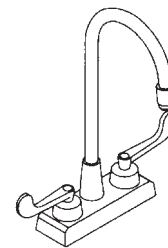

Triton

Centerset lavatory faucet. 5-1/4" gooseneck spout. Wristblade lever handles. Less drain and lift rod. For 4" centers. Chrome plated.

Number	OEM No.
*****	K-7305-5A

***** *Special ordered item*

M•POWER™

1. Simplified Maintenance: Easy-Access Design

Above-deck models feature a two-piece body for faster maintenance

2. Optimized Performance: Self-Adaptive Sensor Technology

Adjusts to the environment to work properly without having to make sensor adjustments. A slow-closing solenoid reduces water hammer

3. Vandal-Resistant Operation: Smart Sensor Placement

Sensors located on the underside of the spout deter tampering

4. Water Savings: Eco-Performance Aerators

A 0.5 gpm aerator reduces water use by 77% compared to standard 2.2 gpm designs

Worry-Free Quality: Best-in-Class Five-Year Limited Warranty



Tired of crawling on the bathroom floor to change batteries/solenoids?
Upset with hearing there aren't replacement parts for your faucet?
Wish there was an easier way?

Introducing Moen Commercial above deck electronic faucets
CA8305, CA8306, CA8307, CA8308

- Sensor lens replaceable
 - 4" & 8" deck plates available
 - 4 – AA batteries last up to 300,000 cycles
 - All access to batteries/solenoids above deck
 - CA8307/CA8308 standard with manual override
- CA8307/CA8308 works great for dialysis rooms (17097,17012,17022)



Single-mount and center-set models with below-deck controls



Above-deck models with built-in handle for manual operation and temperature control



Above-deck models



Deck and wallmount gooseneck models

All sensor-operated faucets are available with AC power or battery power options

 **MOEN**
COMMERCIAL
www.moencommercial.com

Tub & Shower Valve

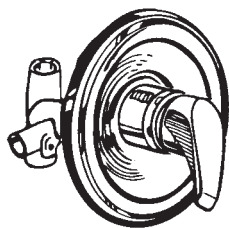

ADA



Moen pressure balancing tub/shower valve. 4 port with integral stops. Copper sweat.

Number	OEM No.
75256	L2361

Kitchen Faucets

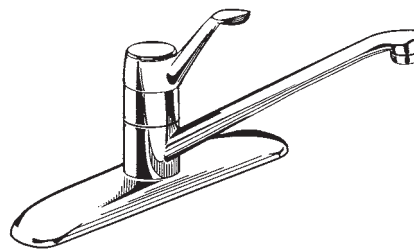

Moen single handle kitchen faucet. Chrome handle. 2.2 gallons per minute @ 60 PSI. 8" centers.

Number	OEM No.
75240	7425

Lavatory Faucets

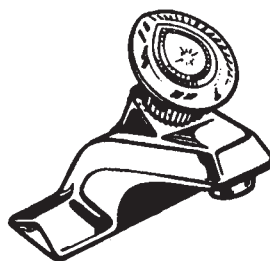

Moen single handle lavatory faucet. Crystal handle. Chrome with 4" centers. Drilled for pop-up drain. 2.0 gallons per minute @ 60 PSI.

Number	OEM No.	Description
75247	64601	Less pop-up
75248	64621	With pop-up

ADA

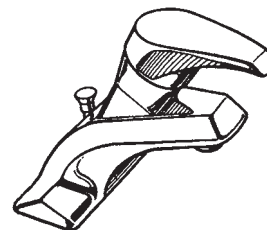

Moen single lever lavatory faucet. Chrome handle - drilled for pop-up. 2.0 gallon per minute @ 60 PSI.

Number	OEM No.	Description
75246	L64601	Less pop-up
75258	L64621	With pop-up

EVERY DAY DEPENDABILITY



1-800-453-1445

POWERS

Hydroguard

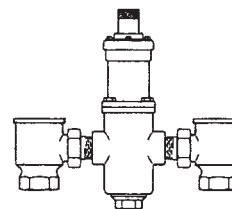

Thermostatic valve. Standard temperature range 90°F - 160°F. Rough bronze.

Number	OEM No.	IPS Inlet	IPS outlet
****	LFMM431-10	3/4"	3/4"
****	LFMM432-10	3/4"	1"
****	LFMM433-10	1-1/4"	1-1/4"
****	LFMM434-10	1-1/4"	1-1/2"

**** Special ordered item

Faucets



On-Q™

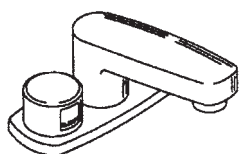

Hand wash faucet. 5-1/4" spout reach, for dual water supply, check valves included. Hard wire installation - Box transformer. Above deck mixer.

Number	OEM No.	Aerator
*****	ETF660-4-B-ADM	.5 GPM



Sensor operated hand wash faucet. 5-1/4" spout reach, 5-1/2" spout height, for dual water supply. Check valves included.

Number	OEM No.	Aerator	Description
*****	ETF-80-4-B	.5 GPM	Hard wired
75797	EBF-85-4	.5 GPM	Battery

***** *Special ordered item*

Optima Plus



Battery powered. For dual water supply. Check valves Included. 4-9/16" reach, 3-5/8" height. Battery powered.

Number	OEM No.	GPF
75799	EBF-650	.5

SF SERIES



Pedestal style electronic faucet with optional trim plate.

***** *Special ordered item*

Number	OEM No.	Description
*****	SF-2100-4	Transformer powered with or w/o battery backup
*****	SF-2150-4	Battery powered



Gooseneck style electronic faucet with optional trim plate. 2.2 aerator

***** *Special ordered item*

Number	OEM No.	Description
*****	SF-2200-4	Transformer powered with or w/o battery backup
*****	SF-2250-4	Battery powered



4" center set style electronic faucet. 0.5 aerator.

***** *Special ordered item*

Number	OEM No.	Description
*****	SF-2300	Transformer powered with battery backup
*****	SF-2350	Battery powered



SOLIS

Optima solar powered faucet. Works for sunlight or artificial light. Dual infrared sensor, modular design includes sensor, solenoid, circuitry & solar energy module above the sink within a die-cast metal spout. .5 laminar spray head

Number	OEM No.	Description
75794	EAF-275	Single supply faucet (for pre-mixed water only)
**	EAF-275-ISM	With integral spout temperature mixer for hot and cold water supply connection
**	EAF-275-ISM-IC	With integral spout temperature mixer and i.q.-Click feature

** *Special ordered item*

OPTIMA ELECTRONIC FAUCET



6v Lithium battery included. Dual infrared sensor, modular design includes sensor, solenoid, circuitry & battery above the sink within a die-cast metal spout.



Number	OEM No.	Description
75789	EAF-150	Single supply faucet (for pre-mixed water only)
**	EAF-150-IC	Single supply faucet supply connection
**	EAF-150-ISM	With integral spout temperature mixer for hot & cold supply
**	EAF-150-ISM-IC	With integral spout temperature mixer and i.q.-Click feature
**	EAF-150-ISM-DPU-IC	With integral spout temperature mixer, drain pop up and i.q.-Click feature

** *Special ordered item*



SAFETY MIX Shower, Tub/Shower

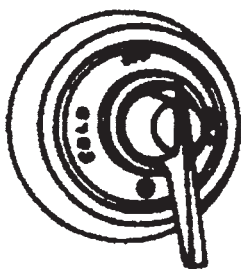

ADA



Valve only. Pressure balancing mixing valve, adjustable temperature limit stop. With integral service stops, lever handle.

Number **OEM No.**
***** 4-500-X

***** Special ordered item

Temptrol Valves



ADA



Tub/shower valve only. Pressure balancing valve, adjustable temperature limit stop, integral diverter and volume control. Tri-corner knob handle. With integral service stops.

Number **OEM No.**
***** S-86-2-X

***** Special ordered item

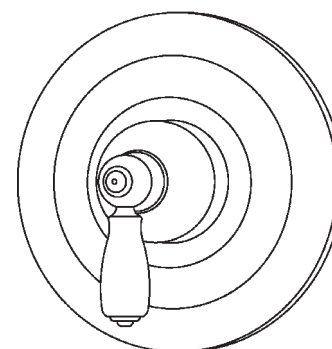
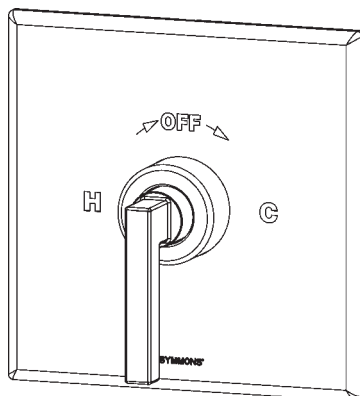
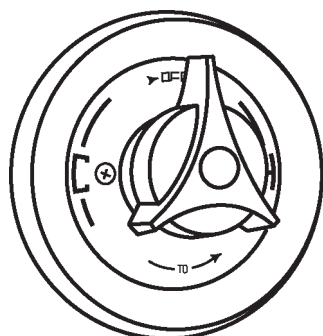
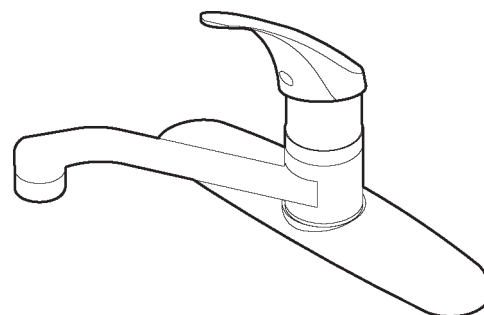
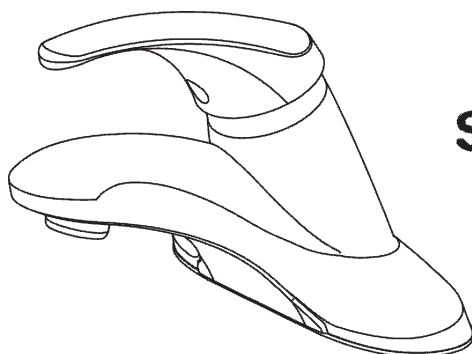

INDUSTRIAL PLUMBING has Symmons repair parts in our Breakdown Section! If you don't see what you are looking for, call us at (650) 368-8517 and we will be happy to assist you.

Faucets



Workboard

ADA

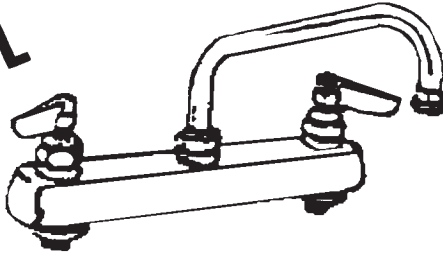

Deck mount, 8" centers, 1/2" IPS male inlets, swing spout, and lever handles. 12" reach, 7-7/8" height and 5-3/16" clearance.

Number OEM No.
75706 B-1123

ADA

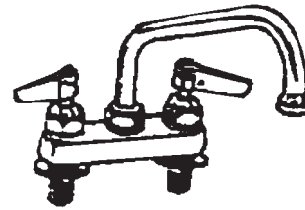

Deck mount, 1/2" IPS male inlets, swing spout and lever handles. 4" hole spacing, 10" reach, 7-1/8" height and 4-7/16" clearance.

Number OEM No.
75707 B-1112

ADA

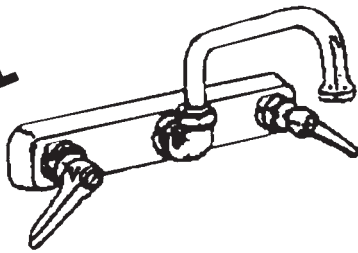

Splashback mount with 8" centers, 1/2" IPS male inlets, swing spout and lever handles. 10" reach.

Number OEM No.
75713 B-1127

ADA

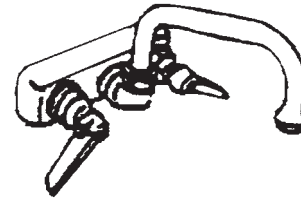

Splashback mount with 4" centers, 1/2" IPS male inlets, swing spout, and lever handles. 10" reach.

Number OEM No.
***** B-1117

***** *Special ordered item*

Glass Fillers

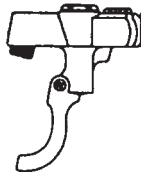

Push back glass filler. 3/8" IPS male inlet, 4-5/16" reach, volume regulator with instantaneous shut-off, and Blue Lexan push arm.

Number OEM No.
75716 B-1205

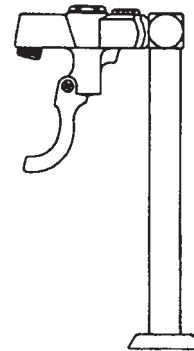

Push back glass filler. 1/2" IPS male inlet shank, 8" outlet clearance, B1205 push back valve, volume regulator with instantaneous shut-off, Blue Lexan push arm.

Number OEM No.
75718 B-1210



Pre-Rinse Units

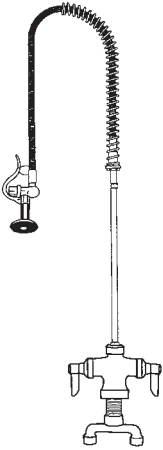

Single hole mount with 1/2" IPS supply spreader (optional 1/4" IPS tailpiece) B107 spray, B44H stainless steel hose, 24" riser, 40" overall height, 15" overhang, and lever handles.

Number	OEM No.
75719	B-113

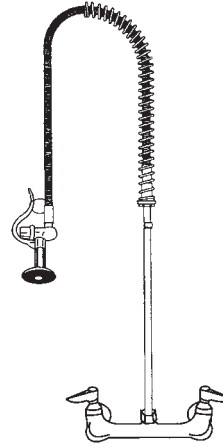

Wall mount faucet, 8" centers, 1/2" IPS flanged female inlets, B44H stainless steel hose, 18" riser, 15" overhang, 34" overall height, B107 straight spray valve.

Number	OEM No.
75721	B-133

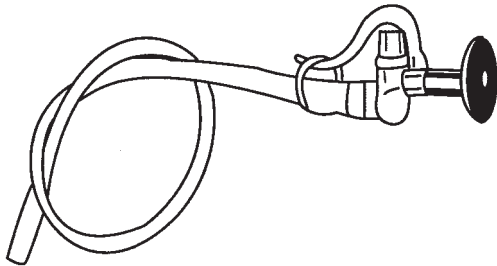

1/2" IPS male connection, B107 straight sprayhead with automatic shut-off valve. 48" length overall. With stainless steel hose B44H.

Number	OEM No.
75723	B-100

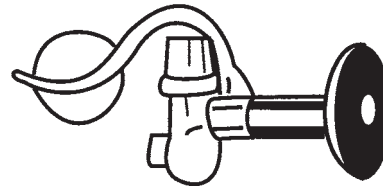

Heavy duty pre-rinse spray, high pressure, used on most T&S pre-rinse units, 2-3/4" spray head diameter, 3/4" hose thread.

Number	OEM No.
88010	B-107

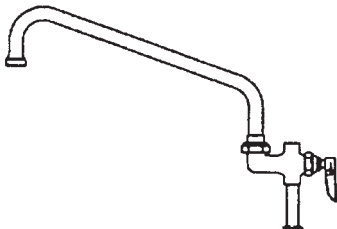

Add-On faucet for pre-rinse units. Lever handle controls water on-off through nozzle only. Pressure is always "on" in riser pipe. 3/8" male inlets, 3/8" IPS female outlet, and 12" spout reach.

Number	OEM No.
75720	B-156

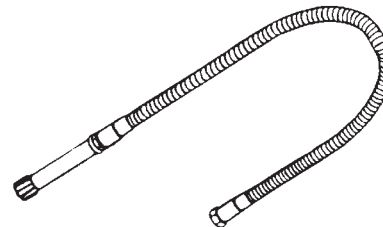

Stainless steel replacement hose. 3/4" inlet, 3/4" outlet, with handle.

Number	OEM No.	Length
88015	B-44-H	44"
88073	B-68-H	68"



Wall bracket for 3/8" OD pre-rinse riser tube with chrome screws. Length can be adjusted by cutting nipple. 6" reach.

Number	OEM No.
88028	B-109-1

Faucets



Wall Mount Sink Faucets

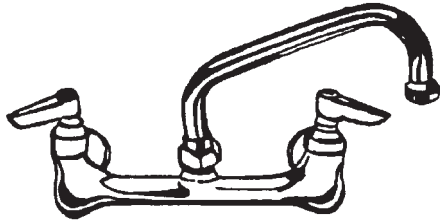

ADA



Sink mixing faucet with 8" centers, 1/2" IPS flanged female inlets, swing spout, lever handles, and 12" reach.

Number **OEM No.**
75701 B-231

Pantry Faucets

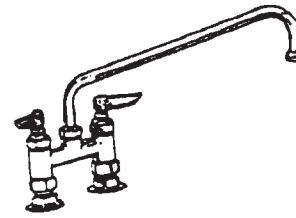

ADA



Deck mount mixing faucet, elevated body, 4" centers, 1/2" IPS flanged female inlets, swing spout, lever handles. 6" clearance, 12" reach.

Number **OEM No.**
75710 B-225

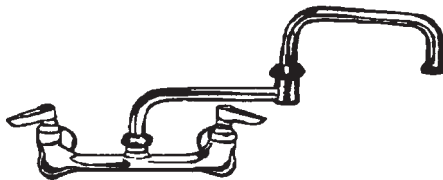

ADA



Combination sink faucet, 8" centers, 1/2" IPS flanged female inlets, double jointed spout, and lever handles. 18" reach.

Number **OEM No.**
75702 B-265

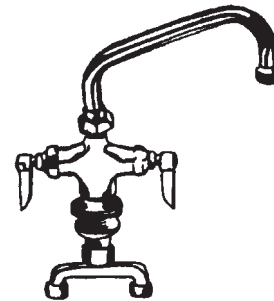

ADA



Single hole 1-1/8" mounting shank, 1/2" IPS supply spreader with 1/4" IPS tailpiece, swing spout, lever handles and 12" reach.

Number **OEM No.**
75709 B-201

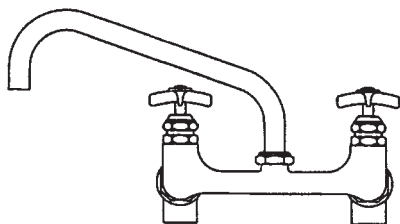

3/4" IPS connections with fixture locknuts, 8" centers, swivel spout, 12" reach from faucet body, plain outlet, and 4-arm handles.

Number **OEM No.**
75705 B-290





**Service Sink
Faucets**



Wall mount, 8" centers, 1/2" IPS flanged female inlets, vacuum breaker spout, 4-3/4" reach, 3/4" hose thread outlet, pail hook, lever handles.

Number	OEM No.	Stops	Finish
*****	B-674-BSTP	Built in	Chrome plated

***** *Special ordered item*

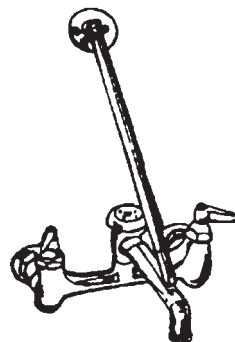

Wall mount, 8" centers, 1/2" IPS flanged female inlets, with integral stops, vacuum breaker spout, 3/4" hose thread outlet, pailhook, wall brace, lever handles, 8-7/8" overall reach. Rough chrome finish.

Number	OEM No.
*****	B-665-BSTR

***** *Special ordered item*

**Centerset
Lavatory
Faucets**

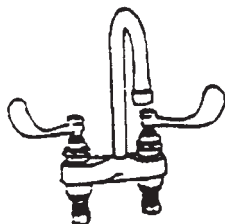

ADA



4" centerset, 1/2" IPS male inlet shanks, gooseneck spout, 4" overall reach, 8-7/8" height, 5" clearance, aerator outlet, 4" wrist blade handles.

Number	OEM No.	Drain
*****	B-892	Less

ORDER DESK



(650) 368-8517

**Basin / Single
Hole Lav
Faucets**

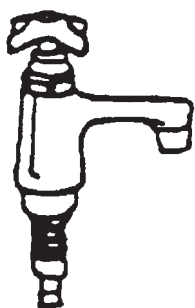

Single basin, 1/2" IPS shank with optional 1/4" IPS tail-piece, 3" reach, 4 arm handle. Manual on/off.

Number	OEM No.
*****	B-710

***** *Special ordered item*

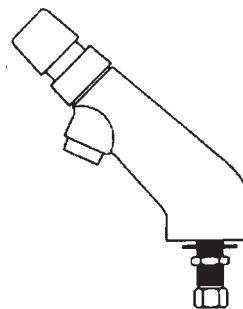

ADA



Metering faucet, vandal resistant, adjustable, self-closing valve, 1/2" IPS shank with optional 1/4" IPS tail-piece, 2-3/4" reach, push handle.

Number	OEM No.
*****	B-805

***** *Special ordered item*

Faucets



Kitchen Faucet



75741

Service sink with 8" cast spout and lever handles.

Laboratory Faucets



75749

Single lab faucet with 5-3/8" gooseneck and lever handle.

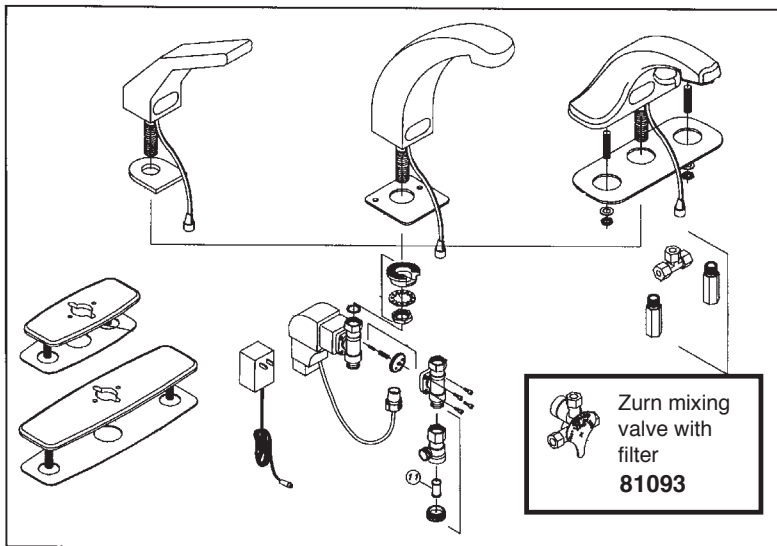

75742

Double lab faucet with 5-3/8" gooseneck and lever handles.

ORDER DESK



(650) 368-8517

FAX LINE

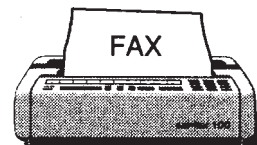

(650) 367-0732



Lavatory Faucets



75736

Centerset with 3-1/2" gooseneck and 4" wrist blade handles.



Widespread with 5" cast spout. Interconnecting copper supply tubes.

Number	Description
75732	Four arm handles
75729	4" wrist blade handles



Widespread with gooseneck.

Number	Gooseneck	Handles
75727	5-1/2"	4" wrist blade handles
75728	5-1/2"	Lever handles



75739

4" centerset with 4" wrist blade handles.



75730

4" centerset with lever handles.



On Demand



Battery powered sensor faucet. Incorporates an infrared convergence type proximity sensor into the cast brass chrome plated base of the gooseneck faucet. Furnished with sensor module, spout and in-line filter, 4 AA batteries, a 1.5 GPM vandal resistant aerator, an inlet for a 1/2" ball riser and single supply hose.

Number	OEM No.
****	Z-6920-XL

**** Special ordered item

On Demand

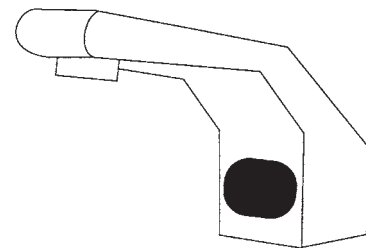

Battery powered sensor faucet for retrofit or new construction. Incorporates a infrared convergence-type proximity sensor into the chrome plated cast brass spout. Includes electronic module and spout module, vandal resistant aerator, battery, and 1/2" NPSM male inlet. Sensor range is factory set which eliminates field adjustments.

Number	OEM No.
****	Z-6912

**** Special ordered item

WHEN YOUR HIGH-RISE BUILDING'S WATER SYSTEM
CALLS FOR LOWER COSTS, **ZURN LISTENS.**

“
Thousands of workers
depend on this building's
water every day. So when
we updated our restrooms
and water systems,
we needed the most
dependable product with
the most value. That's why
we called Zurn.”

RETROFIT AND REPLACEMENT SOLUTIONS

Lead-free backflow preventers and water pressure regulators that fit all current footprints and offer the lowest life-cycle cost. Ultra low consumption urinals and sensor operated faucets and flush valves that conserve water and money. When you need to rethink your building's water system from the ground floor up, there's only one name to consider. Zurn. For your next retrofit and replacement project, give us a call. We'll listen.



ZURN

ZURN

Lavatory Metering Faucets



75751

4" centerset metering faucet.

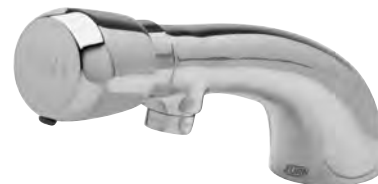

75752 - Cold

Single basin metering faucet.



75748

Wall mounted single metering sink faucet.



75750

Single basin metering faucet.